

**MEYLE**  
**AUTOMATION**  
*Enter The World of Endless Possibility*

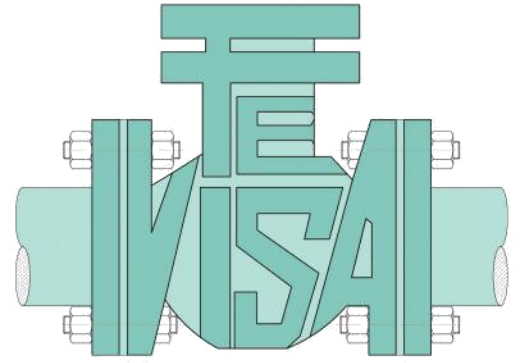

**MEYLE**  
**AUTOMATION**  
*Enter The World of Endless Possibility*

**DISTRIBUTOR &  
DEALER  
IN PAKISTAN**



# VALVULAS FEVISA



*since*

**1968**



# ABOUT FEVISA

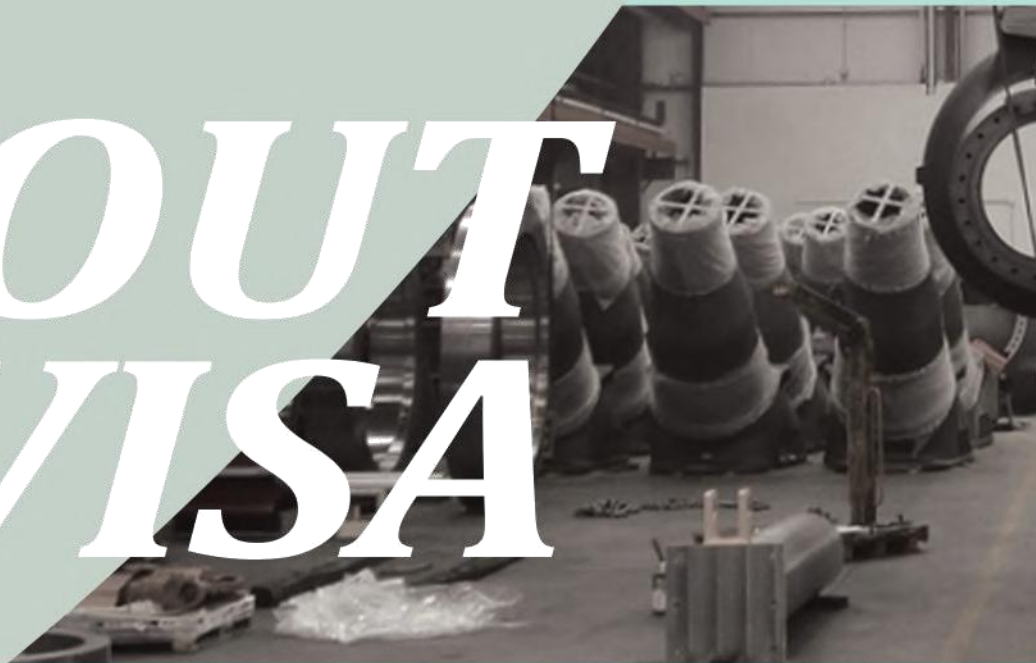

**MEYLE**  
**AUTOMATION**  
Enter The World of Endless Possibilities

**DISTRIBUTOR &  
DEALER  
IN PAKISTAN**

**VALVULAS FEVISA** origins trace back to the Industrially inclined Alvarez family foundry started in the year 1920 in the Industrial Area of Asturias, north of Spain.

VALVULAS FEVISA S.A.U, formerly Talleres Jesus Alvarez S.A was founded in the year 1954 as an industrial machining and fabrication & maintenance services company with a captive foundry by the Alvarez family.

**In 1968, we ventured in manufacturing of Industrial Valves** in collaboration with Spanish and French Valve experts, and created the brand VALVULAS FEVISA and started Design, Engineering & Production of Industrial Valves such as Ball, Gate, Globe, Check, Plug, Valves.

Since then our Valve production facility expanded gradually and currently is of about 80000 Sq. Ft is located at the Industrial Area of VALNALON, north of Spain, equipped with a modern state of the art CNC Lathes, CNC Drilling, CNC Milling, CNC Machining Centers etc. to perform most diverse and complex valve machining process.

FEVISA range of Industrial Valves meet the manufacturing standards set by various international institutions such as the API, ASME, BS, DIN, ISO, AWWA, AFNOR, GOST etc.

Our worldwide clients include Repsol Petroleum, Hunosa, Alumina Espanola, Cepsa, Petronor, Technicas Reunidas, Arcelor Mittal, Intecsa, Hunosa, Petrogal, IC Nalon, Iberdrola, Endesa, Alcoa, Ena Gas, EGPC, GASCO, Nile Gas, ENOC, Tatweer, Occidental, NPCC, DEWA, Dugas, Petronas, Carin Energy Etc.

Quality Control system is implemented and based on the ISO 9000 standard and accredited by Bureau Veritas. Our range of Valves are also certified by American Petroleum Institute vide Certificate Number API 6D-0500. Fire Safe Test Certification per API 6FA is accredited by Grupo Bureau Veritas of Spain.

**In meeting our client's urgent Valves requirements, we distribute through our own business subsidiary Valtronics-Dubai, a 100000 Sq. Ft Valve Inventory Facility, that holds various range of Valves worth more than 20 Million Euros!**



We are currently in the process of building our Valve Automation division with Chemtork range of actuators adjacent to our Valve facility in Spain and are actively pursuing certification for API 6A wellhead valves for our new range of Wellhead Valves.

**With over 50 Years of experience in manufacturing Industrial Valves**, FEVISA is dedicated in expanding its range of manufacturing & are actively engaging with potential agents and channel partners worldwide.



**MEYLE**  
**AUTOMATION**  
Enter The World of Endless Possibilities

**DISTRIBUTOR &  
DEALER  
IN PAKISTAN**

***Manufacturing  
Valves since 1968!,  
for various industrial  
segments***





### *Oil & Gas*

*Downstream, Midstream, & Upstream Valves  
(Pipeline, Refinery, Derivatives)*

### *Chemical*

*Petrochemical, Refinery Chemical, Basic Chemical  
Valves*

### *Power & Water*

*Thermal & Natural Gas Power Plants, Boilers,  
Steam Systems, Desalination Plants, Sewage  
Treatment Plants*

### *Marine*

*LNG & LPG, CNG Vessels, Oil Tankers,  
Cargo Ships, Barges*

### *Mining*

*Plug & Slurry Valves for mining industry*

### *General Industrial Valves*

*Food & Beverage Units, Edible Oil Plants, Paper  
Plants, Solar Industry*

### *Water Infrastructure & Fire Water Valves*

*Resilient Seated and Metal Seated Valves  
conforming to BS, DIN, GOST,  
& AWWA STANDARDS*



# *The Range of Valves FEVISA Manufacture*



- ▶ ***Ball Valves Trunnion***
- ▶ *Ball Valves Top Entry*
- ▶ ***Globe Valves***
- ▶ *Butterfly Valves*
- ▶ ***Through Conduit Valves***
- ▶ *ESD Valves*
- ▶ ***Strainers***
- ▶ *Ball Valves Floating*
- ▶ ***Gate Valves***
- ▶ *Check Valves*
- ▶ ***Plug Valves***
- ▶ *Needle Valves*
- ▶ ***Marine Valves***
- ▶ *Cryogenic Valves*





## END CONNECTIONS:

ANSI RF, RTJ, BW, NPT and SW Ends

## SIZES:

1/4" to 60" – all industrial sizes

## PRESSURE:

ANSI 150, 300, 600, 900, 1500, 2500

## MATERIALS:

Carbon Steel, Stainless Steel, Alloy Steel,  
Duplex, Monel, Inconel, Hastelloy,  
Aluminum Bronze etc.



All Valves Supplied with EN10204 3.1 certificate, a combined material and hydro test certificate conforming to NACE MR 01 75.

## APPROVALS OF VALVULAS FEVISA INCLUDES:

- ▶ ISO 9001:2000, ENAC Certification
- ▶ ISO 9001:2000, UKAS Quality Management System
- ▶ Certified by American Petroleum Institute API 6D
- ▶ API 6FA Fire Safe Certification



**MEYLE**  
**AUTOMATION**  
Over The World of Control Products  
DISTRIBUTOR &  
DEALER  
IN PAKISTAN

# FEVISA

## Wellhead Valves

**MEYLE**  
**AUTOMATION**  
Enter The World of Industry Possibilities  
DISTRIBUTOR &  
DEALER  
IN PAKISTAN

With design transfer & outsourcing support from the formerly Veda Valves UK, now merged with VALVULAS FEVISA, to meet the demands of Wellhead Valves in the upstream section of the Oil Industry, are now outsourcing major components and assembling and testing wellhead valves at our facility in Spain and Dubai.

### THE RANGE OF FEVISA WELLHEAD VALVES & EQUIPMENT INCLUDE

- ▶ **Wellhead Gate Valves**
- ▶ **Choke Manifolds**
- ▶ **Blow-Out Preventers (BOP)**
- ▶ **Surface Wellhead System**
- ▶ **Surface Safety Valves**
- ▶ **Wellhead Choke Valves**
- ▶ **Kill Manifolds**
- ▶ **Wellhead Control Equipment**
- ▶ **Wellhead Check Valves**
- ▶ **Wellhead Control Panels**

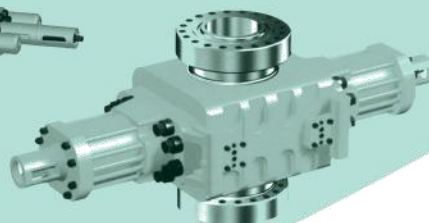
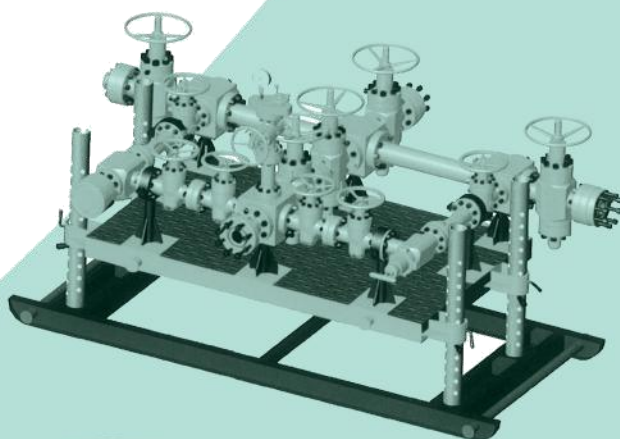
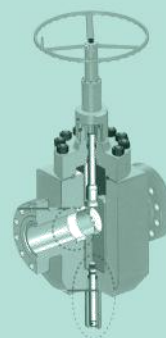



# CHEMTORK

## Automation S.L



**MEYLE**  
**AUTOMATION**  
Enter The World of Endless Possibilities  
**DISTRIBUTOR &  
DEALER  
IN PAKISTAN**



*Chemtork Automation S.L manufactures range of Pneumatic, Electric, Hydraulic & Gas Over Oil Valve Actuators and is now moved from the UK to a new facility in Spain, formerly Chemtork UK Limited.*

*To meet the increasing demands of Valve Automation, Chemtork Automation in association with VALVULAS FEVISA are now strategically positioned to bring down valve automation cost with the extensive Actuator Inventory & Assembling Capability.*

### **THE RANGE OF ACTUATORS INCLUDE THE FOLLOWING:**

- ▶ **Rack & Pinion Pneumatic Actuators**
- ▶ *Scotch & Yoke Pneumatic Actuators*
- ▶ **Electrical Actuators**
- ▶ *Gas over Oil Actuators*
- ▶ **Hydraulic Actuators**
- ▶ *Hydraulic Power Packs*
- ▶ **Line Break Control Systems**
- ▶ *Control Panels for Valve Automation*
- ▶ **Control Components including Air Filter Regulators, Limit Switches, Solenoid valves, associated tubing etc.**

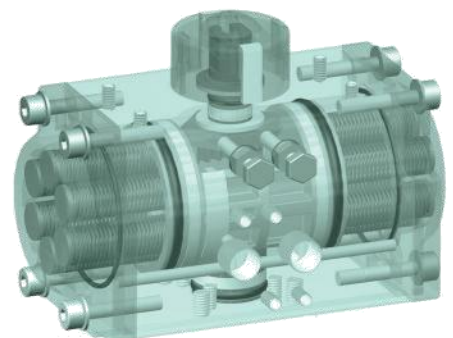
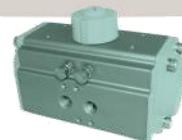
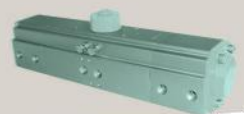



**MEYLE**  
**AUTOMATION**  
Enter The World of Endless Possibilities  
**DISTRIBUTOR &  
DEALER  
IN PAKISTAN**

# ABOUT VALTRONICS

*Valtronics DWC is owned by the management of VALVULAS FEVISA Spain & are the **Largest Stockist** of Industrial Valves in the Middle East and serving our client's **urgent valve requirements** worldwide.*

*Our clients have no more to worry about long lead delivery of valves. We understand the time constraint associated with completion of Oil & Gas Projects. Valtronics **holds inventory of about 20 Million Euros worth of Valves** at our Dubai World Central facility.*

*The new facility at the Dubai World Central is a 100,000 Square Feet warehouse, which also includes a state of the art valves testing facility, machining facility to repair and assemble valves.*





*Our range of Inventory includes up to 36" ANSI 150 Gate Valves & up to 24" ANSI 600 Ball Valves*

***AVAILABLE READY STOCK!***

*We value your time and our team of engineers shall respond to your inquiries the moment they are received, and provide the best delivery time possible which in most cases are EX-STOCK!*



## QUALITY ASSURANCE:

All our valves are designed, manufactured, inspected and tested by the manufacturer under a very efficient quality system verified by Bureau Veritas (BVQI), which assures the best quality for the valves.

However, if there is any secondary testing of the valves required by the client, the same can be performed at our facility in Dubai. This shall ensure high quality valves are installed.

## WARRANTY:

Our valves come with a warranty up to 12 months from date of installation and 18 months from the date of delivery; from which the quality of valves is evident. **At rare instances, we extend our warranty to even up to 5 years, subject to terms and conditions.**

## LIABILITY INSURANCE POLICY:

Liability insurance for your staff personnel operating our valves is covered under this policy. Basic coverage, civil responsibility & liability goods and products, etc. is covered up to one million euros.

# LOCATION

## VALVULAS FEVISA S.A.U

Calle La Siderurgia, Parcela 4-1, Apartado 29.  
Ciudad Industrial VALNALON  
33930 - La Felguera (ASTURIAS), Spain



**MEYLE**  
**AUTOMATION**  
Enter The World of Endless Possibilities

**DISTRIBUTOR &  
DEALER  
IN PAKISTAN**

